

# PVC Express Plantation Shutters

## Component Dimensions

Tools for Success! Use this handy guide to understand the exact dimensions of the Plantation Shutter Components.

Used in conjunction with your Check Measure Worksheet & Panel Layout Chart, this guide will ensure you get the best possible result when measuring for your Plantation Shutters.

### Blade Profiles

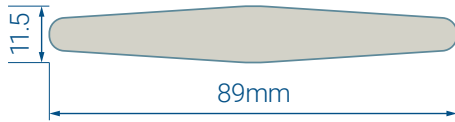

### Rails: Mid Rails

Side View

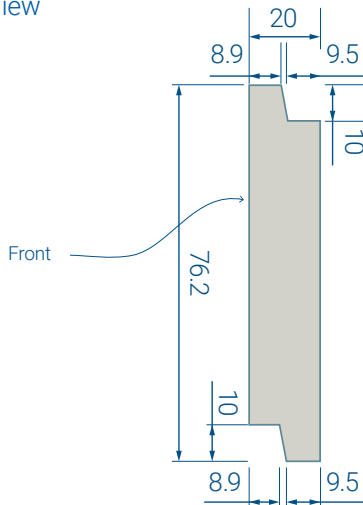

### Rails: Top & Bottom Rails

Side View



Top and Bottom Rail Heights are variable based on the height of the shutters - see table below

Top & Bottom Rail Specifications	
Panel Height	Rail Height
< 900mm	82 - 120mm
901 - 1400mm	92 - 130mm
1401 - 1800mm	112 - 150mm
> 1800mm	132 - 170mm

### Stiles: Beaded Stile

Top View, Single Panel

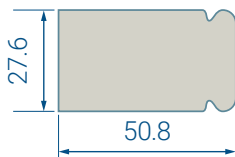

### Stiles: Beaded Stile - D-Mould on RH Panel

Top View, Two Panels closing in centre

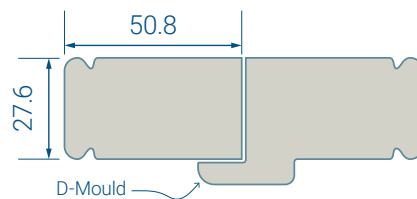

### Frames: Inside Mount Beaded L Frame

Top View

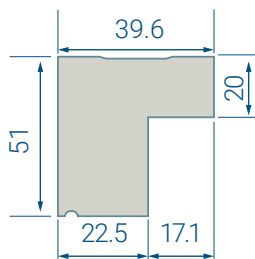

### Frames: Outside Mount Beaded L Frame

Top View

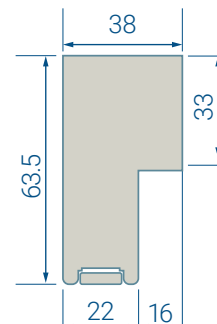

# PVC Express Plantation Shutters

## Component Dimensions

Tools for Success! Use this handy guide to understand the exact dimensions of the Plantation Shutter Components.

Used in conjunction with your Check Measure Worksheet & Panel Layout Chart, this guide will ensure you get the best possible result when measuring for your Plantation Shutters.

### Frames: Inside Mount Z Frame

Small Bull Nose, Top View

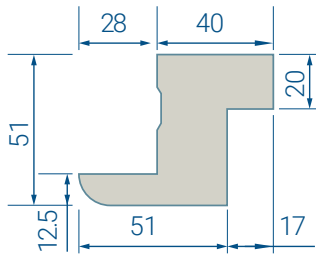

### U Channel: Top

Side View

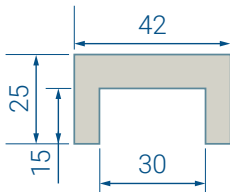

### U Channel: Bottom

Side View

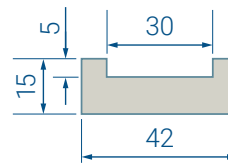

### T-Post Beaded

Top View

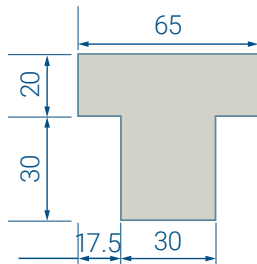

### Tilt Rod

A single Clearview Tilt Rod can hold 12 blades maximum - Approx. 1200mm in Drop without a Midrail



Panel Size Max Widths		
Shutter Panel	Max Width	Max Drop
PVC	950mm	2420mm

Midrail Requirements	
Panel Drop for PVC	# of Midrails
< 1599mm	No Midrail required
1600 - 2420mm	1 x Midrail

Midrail Position Variation	
Centre	+ / - 37mm
Equal	+ / - 37mm
Other	+ / - 37mm
Critical	<b>Exact position</b> - Write "Critical Midrail" in notes section when placing order